



SMOKEY JOE® PREMIUM CHARCOAL GRILL

Read owner's guide before using the barbecue.

Lisez le guide d'utilisation avant d'utiliser le barbecue.

Lesen Sie das Benutzerhandbuch, bevor Sie den Grill verwenden.

14½ inch
(37 cm)



54233 EU 080812

Smokey Joe Premium_EURO 080812

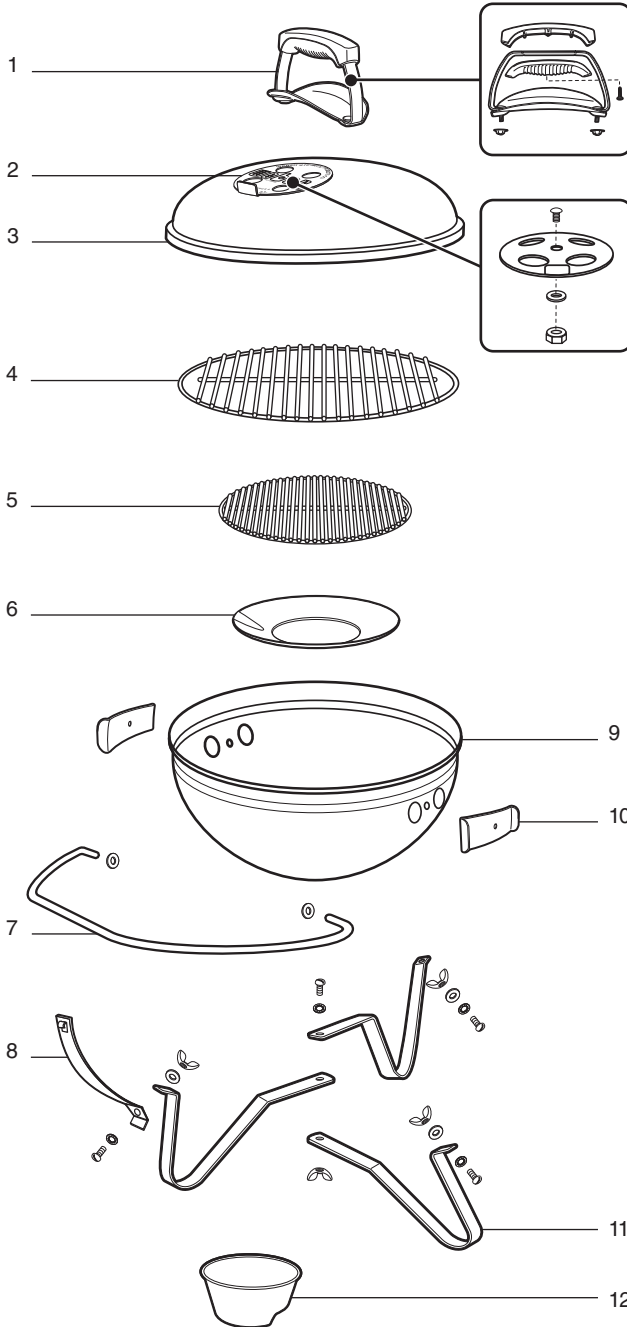

1. **Lid Handle Assembly**
Poignée du couvercle
Deckelgriff
2. **Lid Damper Assembly**
Clapet ventilation
couvercle
Deckellüfter
3. **Lid**
Couvercle
Deckel
4. **Cooking Grate**
Grille de cuisson
Grillrost
5. **Charcoal Grate**
Grille foyère
Holzkohlerost
6. **Ash Catcher**
Coupelle cendrier
Ascheauffangschale
7. **Lid Lock**
Verrouillage couvercle
Deckelverriegelung
8. **Lid Lock Support**
Support de verrou de
couvercle
Strebe für
Deckelverriegelung
9. **Bowl**
Cuve
Kessel
10. **Bowl Damper**
Clapet ventilation
couvercle
Lüfter am Kessel
11. **Leg**
Pied
Beine
12. **Charcoal Cup**
Doseur à Charbon de Bois
Brikett-Portionierer

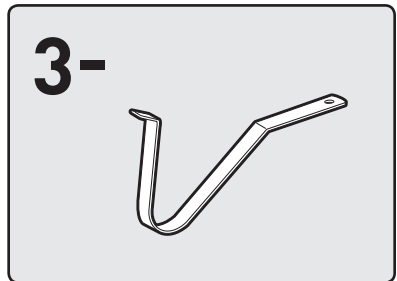
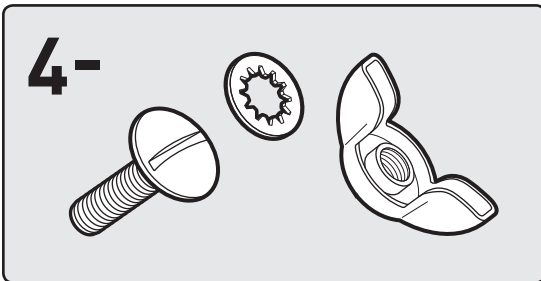
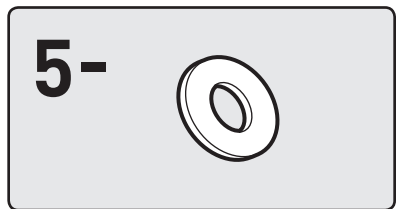
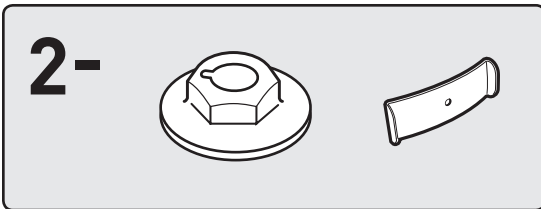
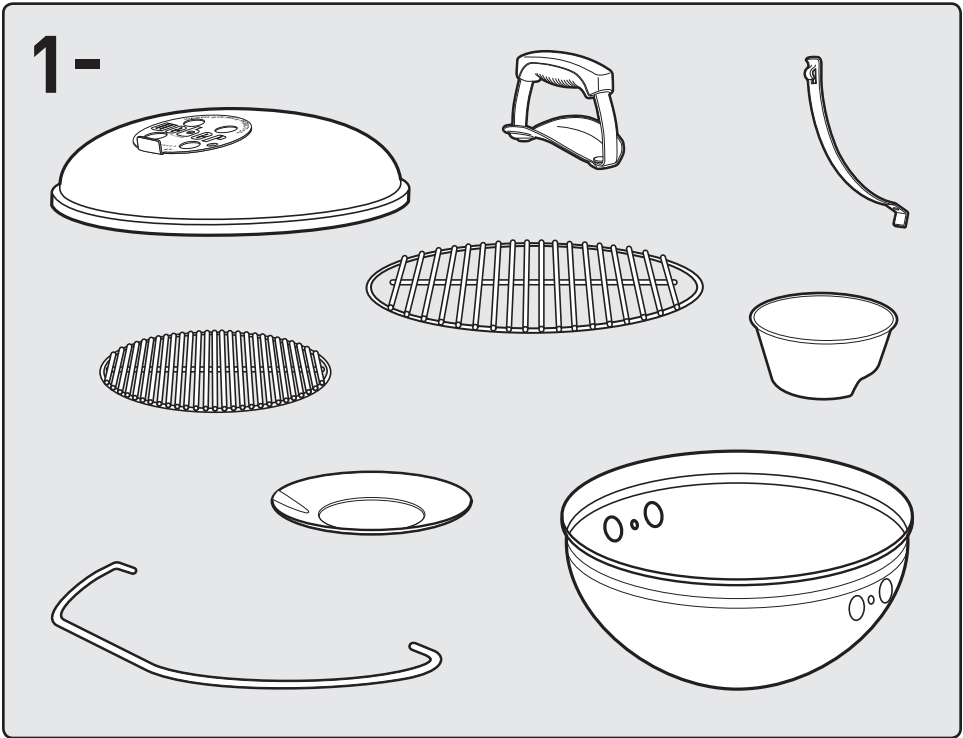
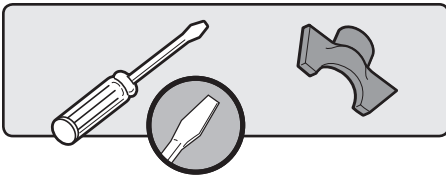

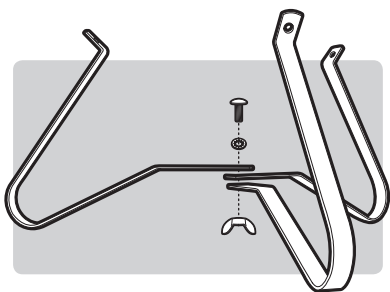
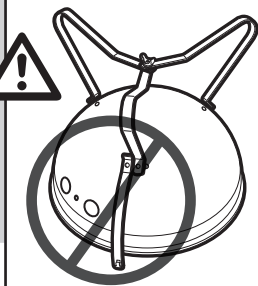
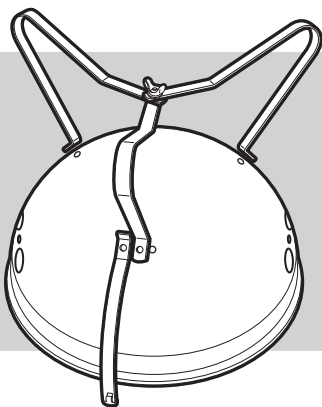
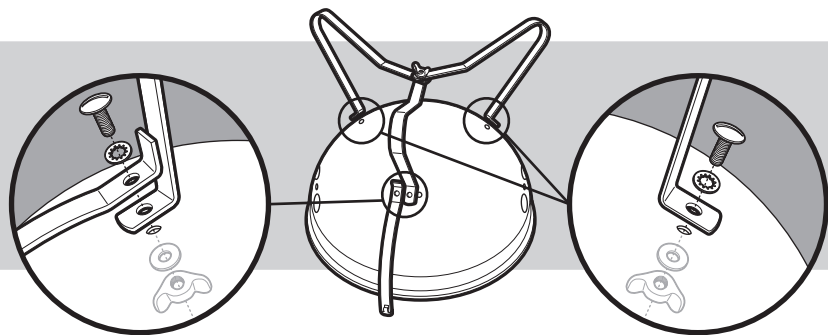
1**1-****2****1-****3****3-**

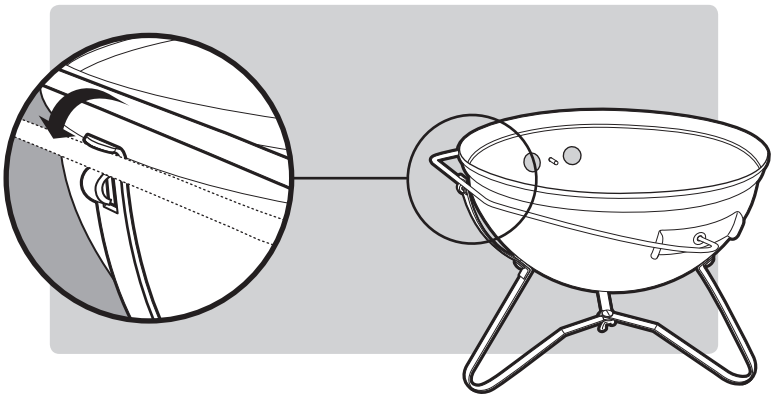
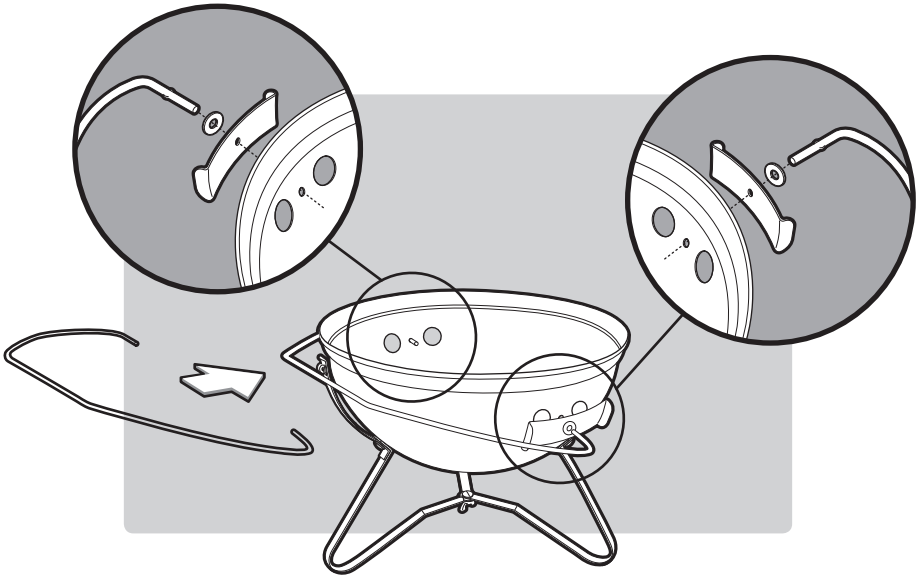

5

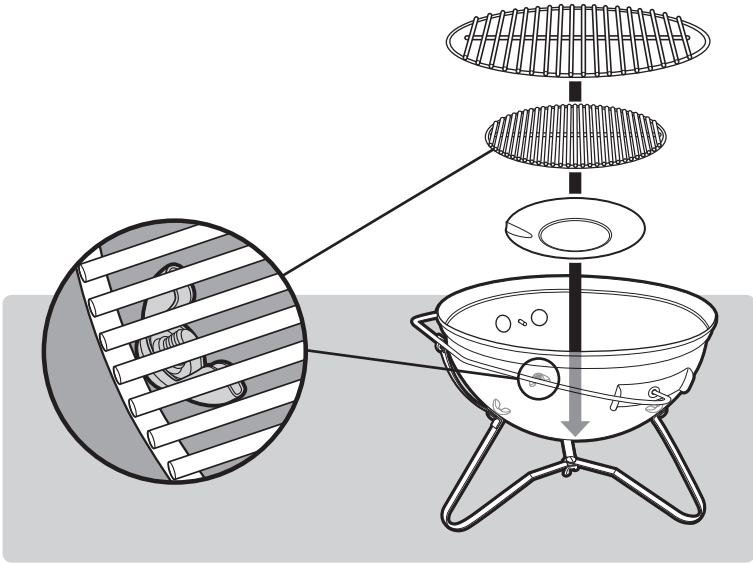

6

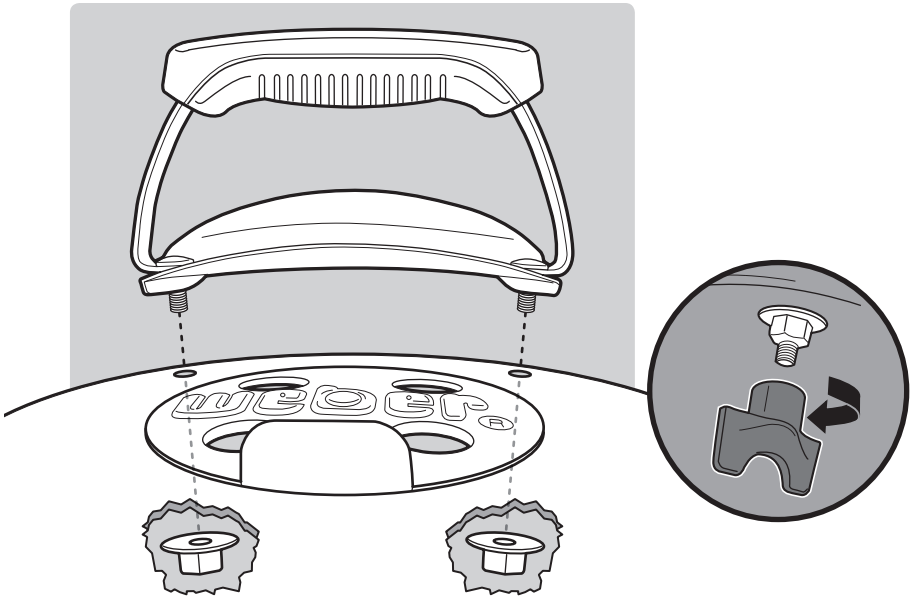

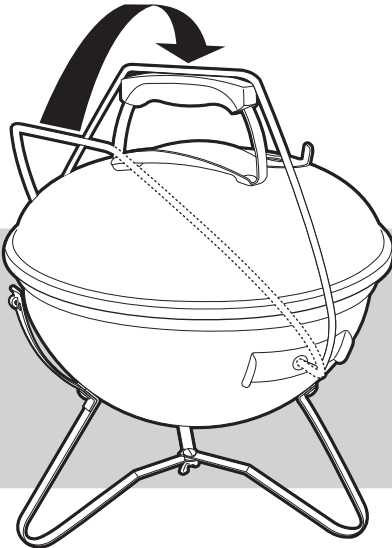
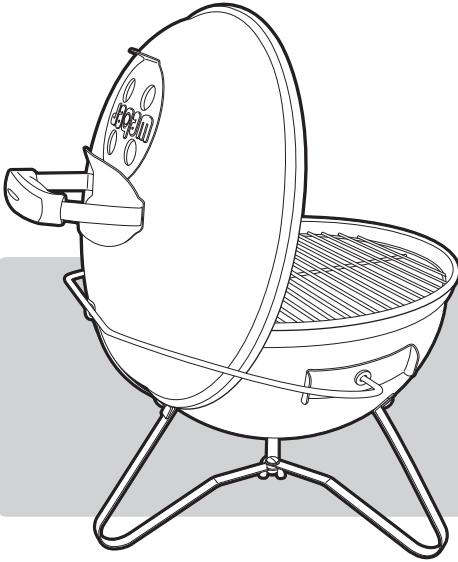



WEBER-STEPHEN PRODUCTS LLC
www.weber.com[®]

© 2012 Designed and engineered by Weber-Stephen Products LLC,
a Delaware limited liability company, located at 200 East Daniels Road, Palatine, Illinois 60067 U.S.A.
Printed in U.S.A.